



MADE IN ITALY

terraneo

**LA NOSTRA STORIA NASCE
70 ANNI FA IN UNA PICCOLA
BOTTEGA IN BRIANZA**

**OUR HISTORY STARTED 70 YEARS AGO IN A
SMALL WORKSHOP IN BRIANZA**



Fondata da Terraneo Oreste nel 1951, da oltre tre generazioni l'azienda porta avanti la tradizione delle aziende produttrici di mobili della Brianza. In oltre 70 anni di esperienza, l'azienda ha scelto la strada della continua ricerca di innovazione, unita al valore fondamentale della tradizione artigiana della Brianza.

Founded by Terraneo Oreste in 1951, for over three generations the company has continued the tradition of wholesale furniture manufacturing in Brianza. In over 70 years of experience, the company has pursued the continuous research for innovation, combined with the fundamental value of the Brianza craftsmanship.

OGGI, PRODUCIAMO TUTTI I NOSTRI MOBILI RAGGIUNGENDO TUTTA ITALIA E MOLTI PAESI DEL MONDO.

**TODAY, WE ALL PRODUCE OUR FURNITURE REACHING ALL
ITALY AND MANY COUNTRIES OF THE WORLD.**

Oltre alla sede produttiva di Verano Brianza, abbiamo recentemente aperto una nuova sede logistica dove abbiamo un grande magazzino con tutti i prodotti del catalogo a stock disponibili in grandi quantità. Tutto questo ci permette di servire in modo puntuale e capillare le aziende d'arredamento e le grandi catene del Bricolage sia italiane che europee. Possiamo gestire in tempi brevi e in modo preciso anche le commesse più impegnative. I prodotti sono forniti in kit di montaggio per ottimizzare i costi di spedizione e ridurre le emissioni di CO2.

In addition to the Verano Brianza manufacturing site, we have recently opened a new logistics site where we have a large warehouse with all the products in the catalogue in stock available in large quantities. All this allows us to meet the timescale and distribution requirements of both the Italian and European wholesale furniture company and large DIY chains. We can handle even the most demanding orders quickly and accurately. The products are supplied in self-assembly kits to optimise shipping costs and reduce CO2 emissions.



UTILIZZIAMO LE MIGLIORI MATERIE PRIME ITALIANE PONENDO LA MASSIMA ATTENZIONE AL RISPETTO DELL'AMBIENTE

THROUGH MODERN AND INNOVATIVE PRODUCTION PROCESSES TO GUARANTEE QUALITY AND RELIABILITY.



MADE IN ITALY

Design tutto italiano e metodi di produzione rigorosi

All-Italian design and rigorous production methods

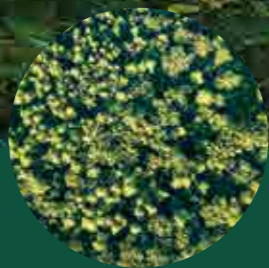

ECO - FRIENDLY

Processi produttivi e packaging attenti all'ambiente

Environmentally-friendly manufacturing processes and packaging



18+ MM SPESSORE 18+ MM THICK

Mobili in kit creati con materiali solidi e di altissima qualità

Flat pack furniture created with the highest quality solid materials



3D TEXTURE

Finitura di altissima definizione per un'alta resa estetica

High-definition finish for an impressive aesthetic result



Il marchio della gestione forestale responsabile
FSC® C107178



FEDERLEGNOARREDO

Scegliamo materiali eco-compatibili e soluzioni tecnologiche avanzate per realizzare un prodotto che è sempre allo stato dell'arte e che allo stesso tempo rispetti l'ambiente. Terraneo è un produttore di mobili che ha sposato la causa della sostenibilità e ha sviluppato cicli di lavorazione eco-friendly che mirano a ridurre gli scarti e le emissioni. Su richiesta del cliente produciamo mobili in kit con pannelli certificati FSC® Misto, ossia realizzati con materiali provenienti da foreste ben gestite e certificate FSC® (Forest Stewardship Council®), materiali riciclati e da altre fonti controllate.

We choose eco-compatible materials and advanced technological solutions to create a product that is always state of the art while at the same time kind to the environment. Terraneo has embraced the cause of sustainability and has developed eco-friendly processing cycles that aim to reduce waste and emissions. At the customer's request we produce flat-packed furniture with FSC® Mixed certified panels, which are made of material from well-managed FSC®-certified forests (Forest Stewardship Council®), recycled materials, and other controlled sources.

CI SIAMO SPECIALIZZATI NEI SERVIZI PER L'ECOMMERCE

HERE WE ARE SPECIALIZED IN ECOMMERCE SERVICES.



**VIDEO TUTORIAL
E ISTRUZIONI
DI MONTAGGIO**
VIDEO TUTORIALS
AND INSTRUCTIONS
BY ASSEMBLY



**SCOPRI I NOSTRI
SOCIAL**
DISCOVER OUR
SOCIAL NETWORK
AND NEWS

Abbiamo sviluppato un nuovo portale b2b per i nostri clienti.
Visibilità dello stock disponibile presso magazzino terraneo in ogni momento.
Trasmissioni ordini immediati
Kit con imballo resistente e di qualità

We have developed a new B2B portal for our customers.
Visibility of available stock at the warehouse at all times.
Immediate order transmission.
Kits with durable and quality packaging.



Facebook



YouTube



LinkedIn

www.shop.terraneo.com

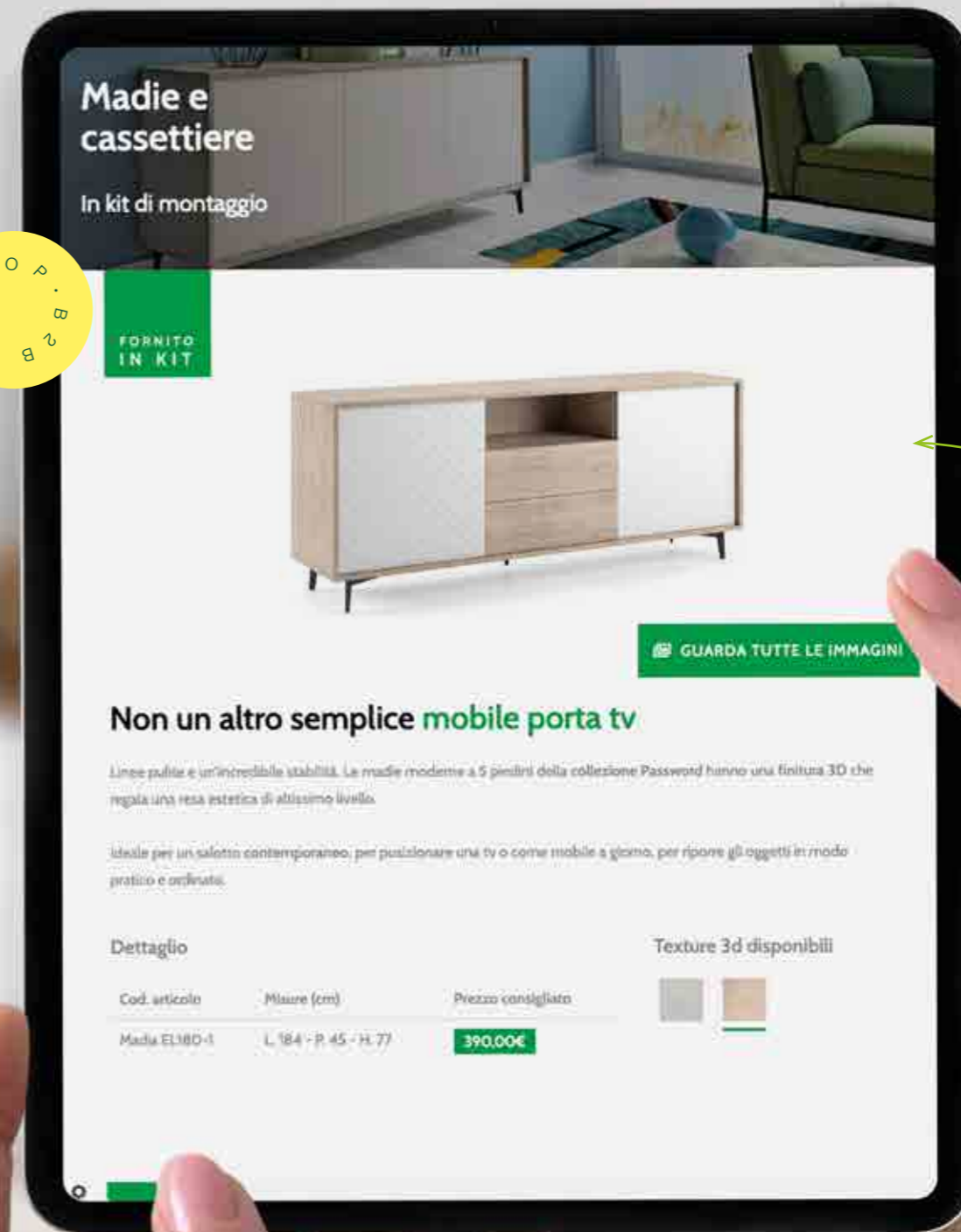

**NUOVA PIATTAFORMA
B2B ONLINE
PER RIVENDITORI:
ORDINI E GIACENZE**

**NEW ONLINE B2B
PLATFORM FOR
RESELLERS: ORDERS
AND INVENTORY BY
ASSEMBLY**

DESIGN ITALIANO, QUALITÀ SENZA TEMPO.

ITALIAN DESIGN, TIMELESS QUALITY.



**CONTENITORI
CABINET**

12

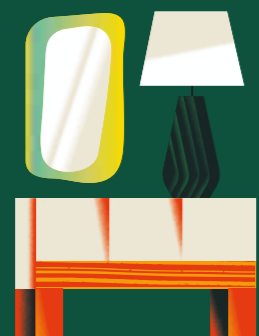

**MADIE
SIDEBOARDS**

54



**LIBRERIE
BOOKCASES**

76



**INGRESSI
ENTRANCE**

86



**SCRIVANIE
DESKS**

106



**TAVOLI
TABLES**

114



**CASSETTIERE
DRAWERS**

126

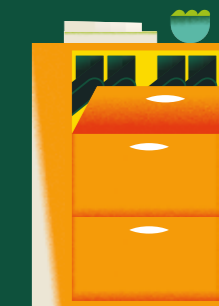

**SCARPIERE
SHOECABINET**

142

CONTENITORI CABINET

Contenitori multiuso: funzionalità e stile si incontrano. Soluzioni versatili per ottimizzare lo spazio, perfette per ambienti piccoli, eleganti e adattabili. Trovate qui la perfezione per il vostro spazio domestico.



IDEALE PER ARREDARE B&B O APPARTAMENTI

IDEAL FOR FURNISHING B&BS OR APARTMENTS

B&B ESSENTIALS

Questa collezione di mobili in kit, dal design moderno ed elegante, è ideale per arredare sia la casa che i bed and breakfast. Caratterizzata da linee pulite, funzionalità e facilità di montaggio, offre soluzioni versatili che si adattano a ogni ambiente e palette di colori, combinando estetica, praticità e semplicità.

This collection of kit furniture, featuring a modern and elegant design, is ideal for furnishing both homes and bed and breakfasts. Characterized by clean lines, functionality, and ease of assembly, it offers versatile solutions that adapt to any environment and color palette, combining aesthetics, practicality, and simplicity.



MADE IN ITALY

LINEA CONTENITORI / CABINET

17



Nuova texture
New texture

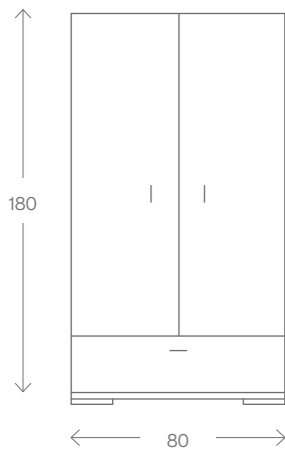

EL 161BCAS

Bianco
White



EL 161BRCAS

Bianco cassetto rovere rigato
White stripped oak drawer

| | |
|-------------------------------|---|
| Dimensioni / Dimension | 80x52x180 cm |
| Confezione / Packaging | 2 Box in Kit |
| Finitura / Texture |   |



Maniglia ergonomica
Ergonomic handle.

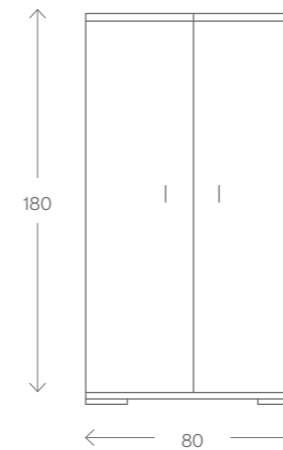

EL 161B

Bianco
White



EL 161BRR

Bianco rovere rigato
White stripped oak

| | |
|-------------------------------|---|
| Dimensioni / Dimension | 80x52x180 cm |
| Confezione / Packaging | 2 Box in Kit |
| Finitura / Texture |   |

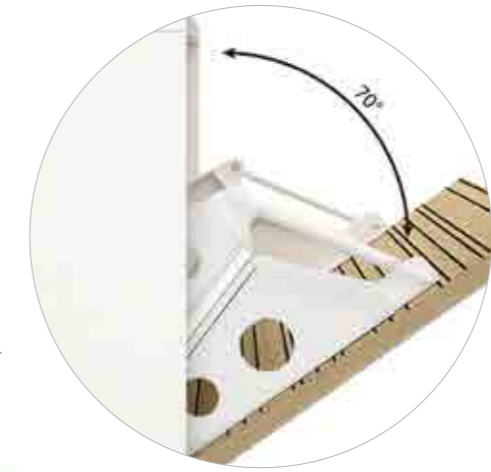

EL 7003BRRIG

Bianco rovere rigato
Striped white oak



EL 7004BRRIG

Bianco rovere rigato
Striped white oak

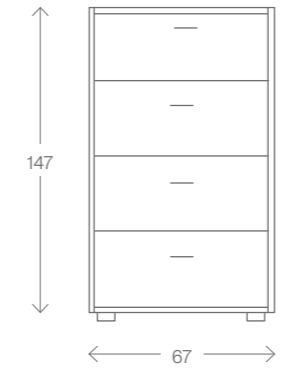
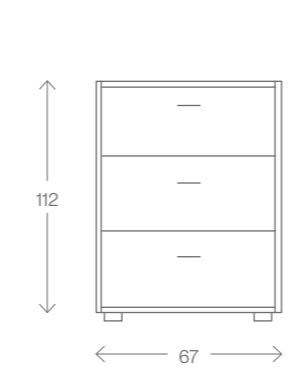

| | |
|-------------------------------|--------------------------|
| Dimensioni / Dimension | 67x28xh112 67x28xh147 |
| Confezione / Packaging | 2 Box in Kit |
| Finitura / Texture | |

VERSATILE, CAPIENTE E MULTIUSO.

VERSATILE, ROOMY AND MULTIPURPOSE.

BOX CONTENITORE

L'assenza di maniglie rende i mobili molto più neutri, adatti ad ogni ambiente e ad ogni configurazione. Il mobile è caratterizzato dalla presenza di 7 ripiani regolabili in altezza. È un elemento compatto che allo stesso tempo offre una capienza importante.

Il mobile basso è composto da 3 ripiani regolabili in altezza per offrire la massima capienza in poco spazio. Il top può essere utilizzato come piano per un ingresso ed è facilmente abbinabile con gli altri elementi della serie.

The absence of handles makes the furniture much more neutral, suitable for any environment and any configuration.

The cabinet is characterized by the presence of 7 height-adjustable shelves. It is a compact element which at the same time offers an important capacity. The low cabinet consists of 3 height-adjustable shelves to offer maximum capacity in a small space. The top can be used as a top for an entrance and can be easily combined with the other elements of the series.

MADE IN ITALY

LINEA CONTENITORI / CABINET

23



NEW PRODUCT

TRE RIPIANI INTERNI REGOLABILI

THREE ADJUSTABLE INTERNAL SHELVES



MADE IN ITALY

LINEA CONTENITORI / CABINET 25



Apertura senza maniglia
Opening without handle



EL 214OLMO

Olmo
Elm



EL 214B

Bianco
White

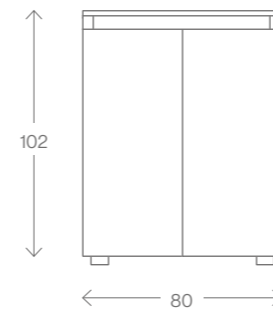

| | |
|-------------------------------|--------------|
| Dimensioni / Dimension | 80x37x102 |
| Confezione / Packaging | 2 Box in Kit |
| Finitura / Texture | |



EL 212OLMO

Olmo
Elm

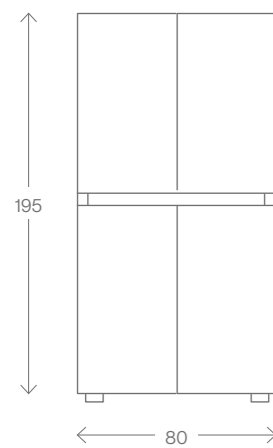

EL 212B

Bianco
White

Dimensioni / Dimension 80x37x195

Confezione / Packaging 2 Box in Kit

Finitura / Texture



MADE IN ITALY

LINEA CONTENITORI / CABINET





MADE IN ITALY



EL 215B

Bianco
White

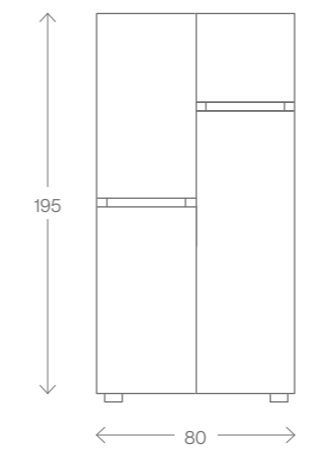



| | |
|-------------------------------|--------------|
| Dimensioni / Dimension | 80x37x195 |
| Confezione / Packaging | 3 Box in Kit |
| Finitura / Texture | |

**EL 213OLMO**

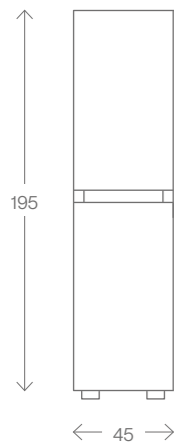
Olmo
Elm

**EL 213B**

Bianco
White



| | |
|-------------------------------|---|
| Dimensioni / Dimension | 45X37X195 |
| Confezione / Packaging | 2 Box in Kit |
| Finitura / Texture |   |

**EL 124OLMO**

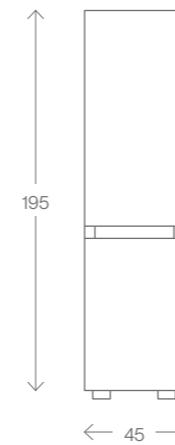
Olmo
Elm

**EL 124B**

Bianco
White

| | |
|-------------------------------|---|
| Dimensioni / Dimension | 45x37x195 |
| Confezione / Packaging | 2 Box in Kit |
| Finitura / Texture |   |

SPAZIOSO, CONFORTEVOLE E BEN ORGANIZZATO.

SPACIOUS, COMFORTABLE AND WELL
ORGANIZED.

COMPOS

Design moderno e grande praticità: questo mobile nasce come comodo armadio multiuso, grazie alle sue due ante. L'interno, inoltre, cela quattro ripiani, perfetti per dare posto a tutti quegli oggetti che non trovano una precisa collocazione in casa. Elegante e funzionale.

A modern and practical concept: this piece of furniture was designed as a comfortable and multipurpose wardrobe, thanks to its two handy doors. Also, the interior hides four shelves, perfect to give place to all those objects that do not find a precise arrangement in the house. Elegant yet functional.



MADE IN ITALY

LINEA CONTENITORI / CABINET

33

BEST
SELLERS



MADE IN ITALY

LINEA CONTENITORI / CABINET 35



EL 112ROV

Bianco ante rovere
White door oak



EL 112CEM

Bianco ante cemento
White door beton

Materiali antigraffio
Scratch resistant
materials

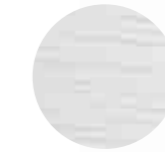

Ripiani regolabili
Adjustable shelves



EL 112B

Bianco ante bianco
White door white

Mobile con doppia anta e quattro ripiani regolabili.
Wardrobe with two doors and four adjustable shelves.

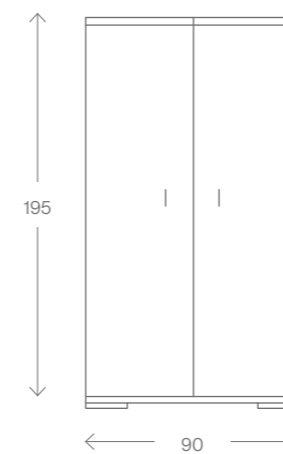

| | |
|-------------------------------|--------------|
| Dimensioni / Dimension | 90x45x195 |
| Confezione / Packaging | 2 Box in Kit |
| Finitura / Texture | |

**EL 113ROV**

Bianco anta rovere
White door oak

**EL 113CEM**

Bianco anta cemento
White door beton

**EL 113B**

Bianco anta bianco
White door white

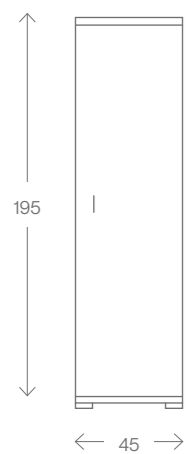
**Dimensioni / Dimension**

45x45x195

Confezione / Packaging

2 Box in Kit

Finitura / Texture

MADE IN ITALY

LINEA CONTENITORI / CABINET



PRATICO, MINIMALE E RICERCATO.

PRACTICAL, MINIMAL AND REFINED.

SLIDE

Design moderno e grande praticità: questo mobile nasce come comodo armadio per l'ingresso o per le stanze di piccole dimensioni, grazie alle sue ante scorrevoli con sistema di bloccaggio. L'interno, invece, cela un tubo porta abiti e ben due ripiani, perfetti per dare posto a tutti quegli oggetti che non trovano una precisa collocazione in casa. Elegante e funzionale.

Design modern et pratique: armoire fonctionnel avec deux portes coulissantes avec un système de verrouillage. A l'intérieur se cache un tuyau porte-vêtements et deux étagères, pour accueillir tout ce qui ne trouve pas d'espace dans la maison. Élégant et pratique.

MADE IN ITALY

LINEA CONTENITORI / CABINET

39





Tubo porta abiti
centrale
Central clothes
hanger tube

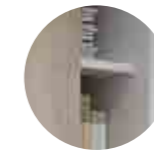

Quattro ripiani interni
regolabili
Four adjustable
internal shelves



Ante scorrevoli
con fermo
Sliding doors
with catch



EL 115/1ROV2RIP

Bianco ante rovere con specchio
White oak doors with mirror

EL 115/1B2RIP

Bianco ante bianco con specchio
White door white



EL 115ROV4RIP

Bianco ante rovere
White door oak

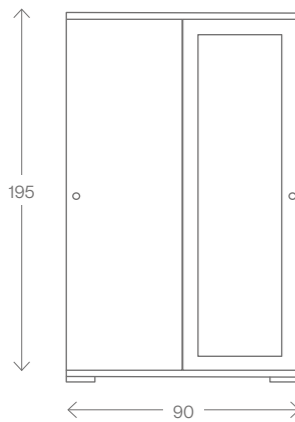

EL 115B4RIP

Bianco ante bianco
White door white

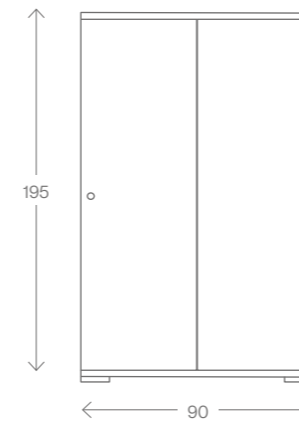

| | |
|-------------------------------|---|
| Dimensioni / Dimension | 90x45x195 |
| Confezione / Packaging | 3 Box in Kit |
| Finitura / Texture |   |



| | |
|-------------------------------|---|
| Dimensioni / Dimension | 90x45x195 |
| Confezione / Packaging | 3 Box in Kit |
| Finitura / Texture |   |

ORDINATO, REGOLABILE E SALVASPAZIO.

ORDERLY, ADJUSTABLE AND SPACE-SAVING.

LAUNDRY

Una soluzione per rendere funzionale anche un ambiente di dimensioni contenute per mantenere tutto in ordine e conservare un progetto di arredo pulito e compatto. La versione salva spazio dal design lineare e moderno con pratico cestone porta biancheria in metallo permette di avere sempre in ordine gli spazi, e il cassetto con guide in metallo telescopiche di avere tutto a portata di mano all'occorrenza. L'anta con ripiano interno regolabile offre spazio aggiuntivo per riporre tutti gli oggetti.

A solution to make useful even a small room, to keep everything in order and create a clean and compact stylish setting. The space-saving column with a linear and modern design with practical metal basket allows you to always have in order the spaces, and the drawer with telescopic metal rails to have everything at your hand when needed. The door with adjustable internal shelf provides plenty of storage space and open compartments to store all objects.

MADE IN ITALY

LINEA CONTENITORI / CABINET

43

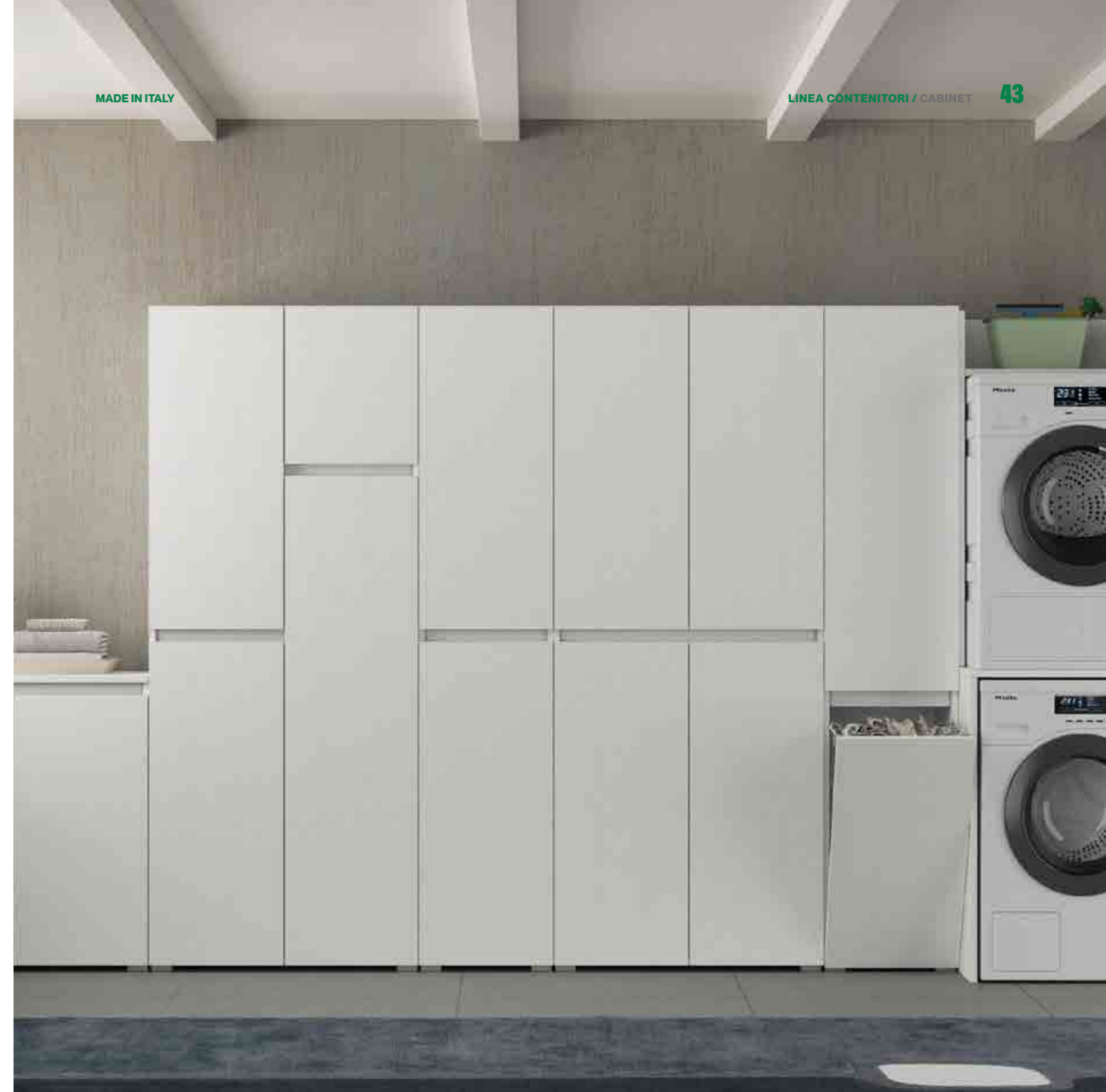





DUE RIPIANI NEL VANO SUPERIORE
TWO SHELVES IN THE UPPER COMPARTMENT

AMPIO CESTELLO IN METALLO
LARGE METAL BASKET



MADE IN ITALY

LINEA CONTENITORI / CABINET **47**



EL 120ROV

Bianco anta rovere
White door oak



EL 120CEM

Bianco anta cemento
White door beton



EL 120B

Bianco
White

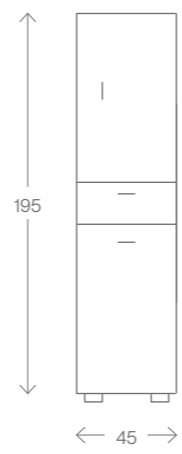

| | |
|-------------------------------|--------------|
| Dimensioni / Dimension | 45x32x195 |
| Confezione / Packaging | 2 Box in Kit |
| Finitura / Texture | |

Ripiano a vista
regolabile
Adjustable visible
shelf



Ripiano nel vano
superiore
Shelf in the upper
compartment



Adatto ad ogni tipo
di lavatrice
Suitable for all
types of washing
machines

EL 123B

Bianco ante bianco
White with white

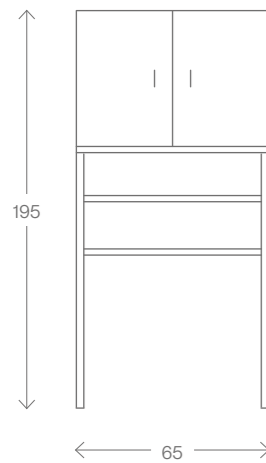

Dimensioni / Dimension 65x32x195

Confezione / Packaging 2 Box in Kit

Finitura / Texture



MADE IN ITALY

LINEA CONTENITORI / CABINET



SELLERS
BEST

SELLERS
BEST

MADE IN ITALY

LINEA CONTENITORI / CABINET

51



EL 126B

Bianco
White

Configurazione 1

Configurazione 2

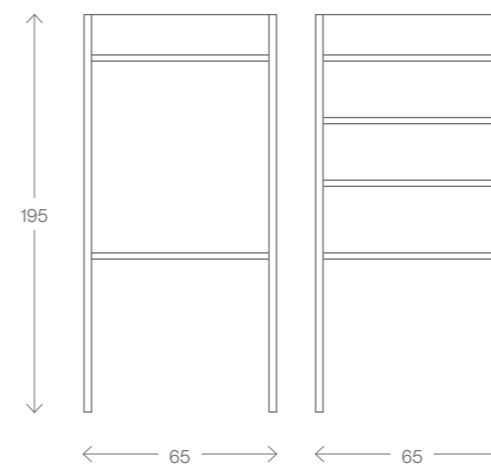

Il mobile lavatrice e asciugatrice offre la possibilità di essere configurato in due modalità distinte: con lavatrice e spaziosi ripiani o con lavatrice e asciugatrice.

Dimensioni / Dimension 65x58x195h

Confezione / Packaging 2 Box in Kit

Finitura / Texture



LINEA MADIE SIDEBOARDS

Le madie per soggiorno e ingresso sono mobili versatili e funzionali, ideali per ottimizzare lo spazio e aggiungere stile. Si adattano a vari stili di arredamento, offrendo spazi di stoccaggio per oggetti quotidiani e decorativi con un aspetto elegante e raffinato.



ESSENZIALE, ELEGANTE E DI DESIGN.

ESSENTIAL, ELEGANT AND DESIGN.

MADIA PASSWORD

Elegante e versatile, questo mobile living presenta linee deliziosamente basic. I cinque piedini in metallo garantiscono un'ottima stabilità, il sistema di apertura senza maniglie dona particolare eleganza. La finitura 3D dell'anta garantisce un elegante effetto estetico. Grazie al suo stile contemporaneo, può essere utilizzato come mobile giorno. Nella versione con tre ante è un ottimo contenitore adatto a riporre i vari oggetti. Ogni vano è organizzato con ripiano interno regolabile.

Stylish and versatile, these living room furniture present lovely basic lines. The five metal feet guarantee excellent stability, the opening system without handles gives it elegance. The 3D finish of the doors guarantees an elegant aesthetic effect. Thanks to its contemporary style, it can be used as a day furniture. In the version with three doors, it is an excellent container suitable for storing various objects. Each compartment is arranged with an adjustable internal shelf.



MADE IN ITALY

LINEA MADIE / SIDEBOARDS

55





MADE IN ITALY



Ripiano interno regolabile
Adjustable shelf



Cerniere con chiusura
push to open
Push to open hinges



Anta 3D in rilievo
dama
Door 3D effect



Piedini in metallo
Metal legs

EL 180/1ROV

Rovere ante bianco DAMA
White square and oak

EL 180/1BETON

Cemento ante bianco DAMA
White square and beton

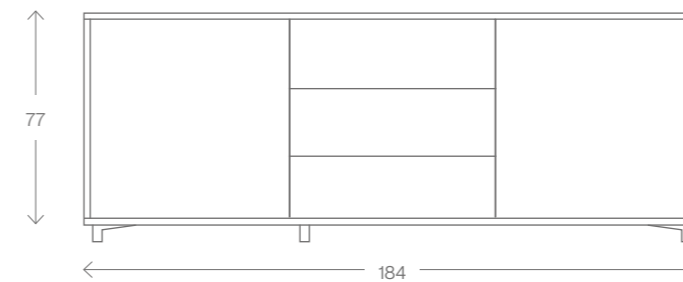

| | |
|-------------------------------|--------------|
| Dimensioni / Dimension | 184x45x77 cm |
| Confezione / Packaging | 3 Box in Kit |
| Finitura / Texture | |



MADE IN ITALY



18 MM DI
SPESSORE
18 MM
THICKNESS





Tre ripiani interni
regolabili
3 adjustable shelves



EL 180ROV

Rovere ante bianco DAMA
White square and oak



Anta 3D in rilievo dama
Door 3D effect



EL 180BETON

Cemento ante bianco DAMA
White square and beton

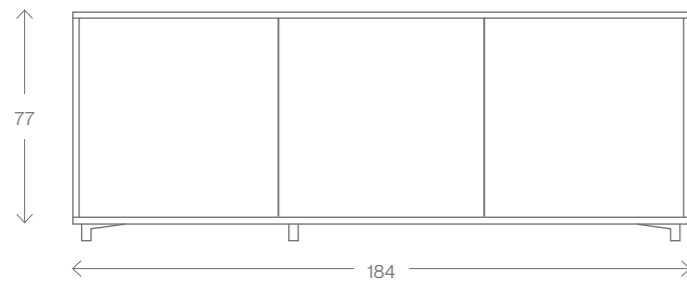

Dimensioni / Dimension 184x45x77 cm

Confezione / Packaging 3 Box in Kit

Finitura / Texture



MADE IN ITALY

LINEA MADIE / SIDEBOARDS



LINEARE, COMPONIBILE E PERSONALIZZABILE.

LINEAR, MODULAR AND CUSTOMIZABLE.

FRAME

Frame è la nuova linea caratterizzata da un telaio disponibile nei colori bronzo e bianco con le ante disponibili nei colori cemento, bianco e cannetè.

La linea è caratterizzata da un telaio che garantisce stabilità, resistenza, solidità alla struttura del mobile. Elementi affidabili con delle linee semplici e basiche, ma allo stesso tempo in grado di arredare la casa. Il sistema di chiusura push, senza maniglie, garantisce un'eleganza unica, con facilità di abbinamento.

L'ampia disponibilità di varianti colore delle ante e delle strutture, permette di avere innumerevoli abbinamenti: è possibile scegliere tra le innumerevoli opzioni.

Frame is the new line characterized by a frame available in bronze and white colors with doors available in cement, white and cannetè colours.

The line is characterized by a frame which guarantees stability, resistance and solidity to the structure of the piece of furniture. Reliable elements with simple and basic lines, but at the same time able to furnish the house. The push closure system, without handles, guarantees a unique elegance, with ease of combination.

The wide availability of color variants of the doors and structures allows for innumerable combinations: it is possible to choose from the innumerable options.

MADE IN ITALY

LINEA MADIE / SIDEBOARDS

63



NUOVO COLORE
NEW COLOR



NEW
PRODUCT

3D TEXTURE
DEL PANNELLO
3D PANEL
TEXTURE



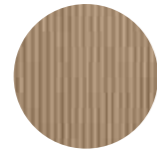

Nuovo colore
New color



Nuovo colore
New color

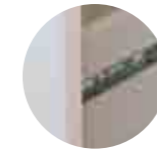

Cassetto centrale con
guide in metallo e sistema
apertura push to open
Drawer with metal slides
and push to open



Solida base portata
Heavy duty base



EL 191BCANCH

Bianco cannetè Chiaro
White light cannetè

EL 191BRZCANSC

Bronzo cannetè scuro
Bronze dark cannetè

EL 191BC

Bianco cemento
White beton

EL 191B

Bianco
White

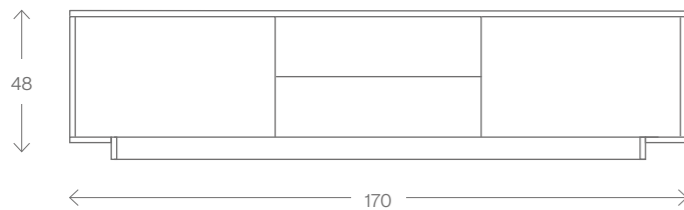

| | |
|-------------------------------|--------------|
| Dimensioni / Dimension | 170x42x48 cm |
| Confezione / Packaging | 2 Box in Kit |
| Finitura / Texture | |

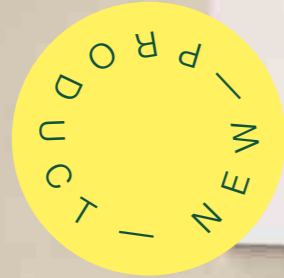
**EL192BCANCH**

Bianco cannetè Chiaro
White light cannetè

MSPECB

Specchio / Mirror

EL192BRZCANSC

Bronzo cannetè scuro
Bronze dark cannetè

MSPECBRZ

Specchio / Mirror

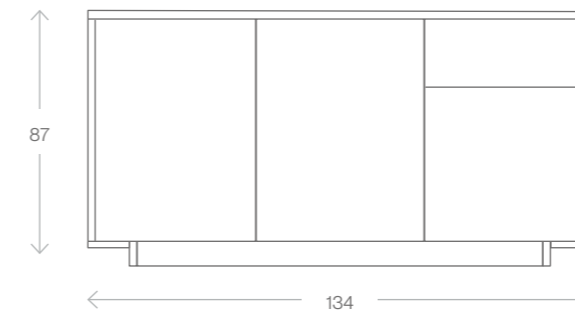
**Dimensioni / Dimension**

| | |
|--------------------|--------------|
| Madie / sideboards | 134x35x87 cm |
| Specchio / mirror | 110x2x60 cm |

Confezione / Packaging

3 Box in Kit

Finitura / Texture



EL 192BC

Bianco cemento
White beton

MSPECB
Specchio / Mirror

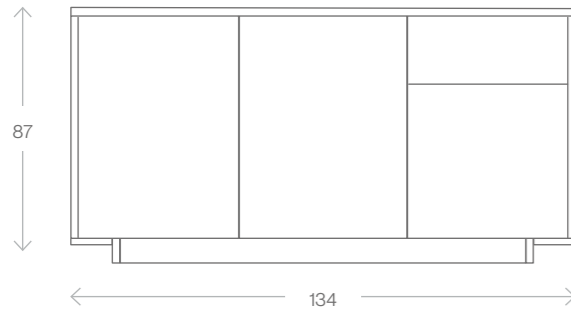

EL 192B

Bianco
White

MSPECBRZ
Specchio / Mirror

| | | |
|-------------------------------|--------------------|--------------|
| Dimensioni / Dimension | Madie / sideboards | 134x35x87 cm |
| | Specchio / mirror | 110x2x60 cm |
| Confezione / Packaging | 3 Box in Kit | |
| Finitura / Texture | | |



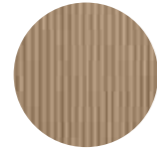

Nuovo colore
New color

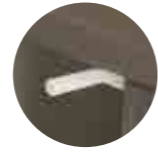

Apertura ante push
to open
Push opening system



Cassetto con guide
in metallo e sistema
apertura push to open
Drawer with metal slides
and push to open



Solida base portata
Heavy duty base



EL 190BCANCH

Bianco cannetè Chiaro
White light cannetè

EL 190BRZCANSC

Bronzo cannetè scuro
Bronze dark cannetè

EL 190BC

Bianco cemento
White cement

EL 190B

Bianco
White

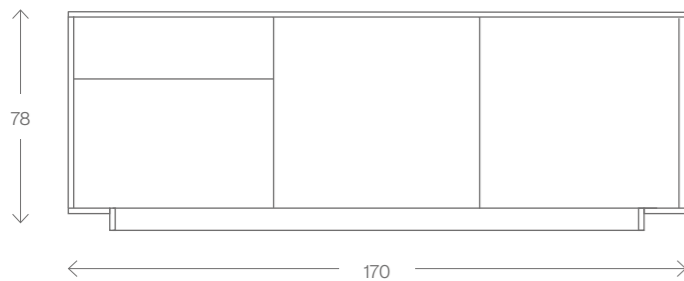

| | |
|-------------------------------|--------------|
| Dimensioni / Dimension | 170x42x78 cm |
| Confezione / Packaging | 3 Box in Kit |
| Finitura / Texture | |

LIBRERIE BOOKCASES

Collezione di librerie che unisce passione per i libri, stile e funzionalità.
Progettate come spazi di stoccaggio e elementi decorativi, disponibili
in stili moderni e classici per soddisfare ogni gusto.



RAFFINATA, STILOSA E PARTICOLARE.

REFINED, STYLISH AND PARTICULAR.

TETRIX

Libreria dal design moderno e minimale adatta per arredare qualsiasi ambiente: in poco spazio grazie ai suoi 5 ripiani puoi riporre al meglio ogni oggetto arredando con gusto e semplicità. Perfetta da posizionare a parete o per dividere gli ambienti, nel soggiorno, camera, cucina, uffici, studio e showroom, offre un'ampia capacità di organizzazione. Ha una struttura semplice e ben progettata, durevole e stabile, offre un tocco raffinato ed elegante agli ambienti di casa o ufficio.

Bookcase with a modern and minimal design suitable for decorating any room: in a small space, it has enough storage space with 5 tier shelves makes it easy to store or display things, furnishing with style and simplicity. Perfect to fix on the wall or to divide rooms, in the living room, bedroom, kitchen, offices, study and showroom, it offers a wide capacity for organization. It has a simple and well designed, durable and stable structure, offering a simple and elegant touch to home or office rooms.



MADE IN ITALY

LINEA LIBRERIE / BOOKCASES

77



BKAF11

Bianco rovere
White oak

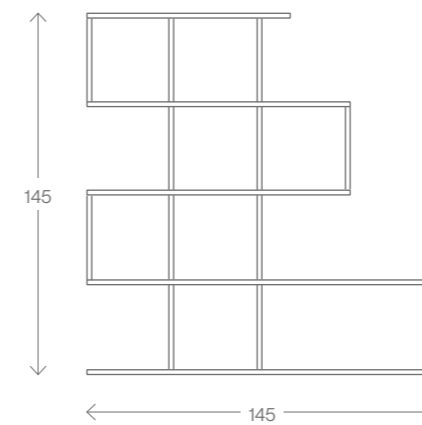

BKAF22

Bianco e cemento
White beton

| | |
|-------------------------------|--------------|
| Dimensioni / Dimension | 145x29x145 |
| Confezione / Packaging | 2 Box in Kit |
| Finitura / Texture | |

COMPATTA, REGOLABILE ED ESSENZIALE.

COMPACT, ADJUSTABLE AND ESSENTIAL.

BOOK

La libreria è da sempre il cuore del salotto, dove libri, cornici e oggetti importanti trovano il loro posto d'onore. Questa libreria, dalle linee basic dall'ispirazione intima, presenta tre comodi ripiani, regolabili in altezza, ideali per diffondere un'eleganza concettuale nella casa.

The bookcase has always been the heart of the living room, where books, frames and important objects find their place of honour. This basic, intimate-inspired base bookcase features three practical adjustable shelves, ideal for spreading conceptual elegance in your home.

MADE IN ITALY

LINEA LIBRERIE / BOOKCASES

81





Tre ripiani regolabili
Three adjustable shelves

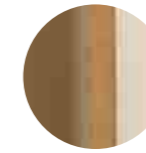

Schienale spessore 6mm
6mm thick backrest



EL 218B

Bianco
White

EL 218BCEM

Bianco, fondo cemento
White, beton back

EL 218BROV

Bianco, fondo rovere
White, oak back

EL 216B

Bianco
White

EL 216BCEM

Bianco, fondo cemento
White, beton back

EL 216BROV

Bianco, fondo rovere
White, oak back

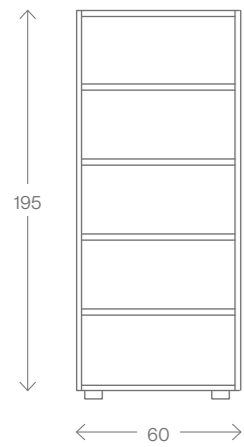

| | |
|-------------------------------|--------------|
| Dimensioni / Dimension | 60x30x195 |
| Confezione / Packaging | 1 Box in Kit |
| Finitura / Texture | |

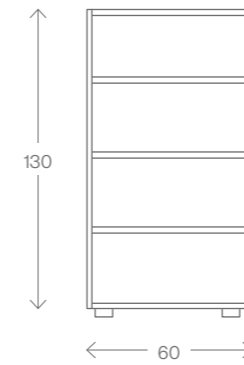

| | |
|-------------------------------|--------------|
| Dimensioni / Dimension | 60x30x130 |
| Confezione / Packaging | 1 Box in Kit |
| Finitura / Texture | |

INGRESSI ENTRANCE

Collezione di mobili per ingresso, composta da bauli contenitori e appendini, che unisce funzionalità e stile. Questi pezzi, dalle linee classiche ai design moderni, offrono spazi di stoccaggio e complementi d'arredo per creare un ingresso accogliente e organizzato.



SEMPLICE, UTILE E PRATICA.

SIMPLE, USEFUL AND PRACTICE.

HALLWAY

Linee pulite e un design molto basico per questa pratica ed accogliente panca d'ingresso. Con le sue molteplici finiture e lo stile semplice, questo arredo versatile completerà sicuramente una serie di camere da letto, corridoi, ingressi, e ogni ambiente domestico. Questo pratico baule bianco offre molto spazio per tenere in ordine tutti gli oggetti, con ampia capacità di stoccaggio per aiutare a tenere in ordine. Abbiamo costruito il baule con un sistema a pistone soft closing per un uso ultrasicuro, quindi tra il bordo e il coperchio in fase di chiusura si crea lo spazio per evitare lo schiacciamento delle dita. Inoltre, quando il coperchio è abbassato, si trasforma in un pratico sedile.

Simple styling and a very basic design for this practical and welcoming entrance bench. With its multiple finishes and simple style, this versatile trunk will surely complete a series of bedrooms, hallway, entrances, and any domestic room. This practical and spacious chest is handy for storing many objects, with ample storage capacity to help to maintain a neat and tidy space. We have built the boxes with a soft closing piston for ultra-safe use, so there is a gap between the edge and the lid when shut, this prevents fingers getting trapped. Furthermore, when the lid is lowered, it turns into a practical seat.

MADE IN ITALY

LINEA INGRESSI / ENTRANCE

87





Doppia cerniera
Double zipper



Snodo per chiusura
rallentata
Joint for slow closing



EL 230BROV

Bianco, top rovere
White top oak



EL 230B

Bianco
White



EL 230BC

Bianco, top cemento
White top beton

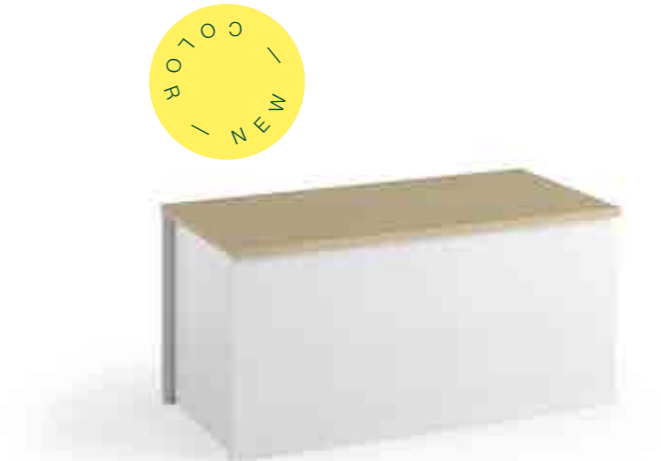

EL 230BCANCH

Bianco, top Canneté chiaro
White top Light cannetè

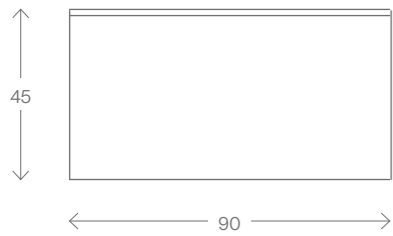

| | |
|-------------------------------|--------------|
| Dimensioni / Dimension | 90x45x45 |
| Confezione / Packaging | 1 Box in Kit |
| Finitura / Texture | |



Doppia cerniera
Double zipper



EL 220BROV

Rovere e bianco
Oak and white



Snodo per chiusura
rallentata
Joint for slow closing



EL 220BC

Cemento e bianco
Beton and white

MADE IN ITALY



EL 220B

Bianco
White

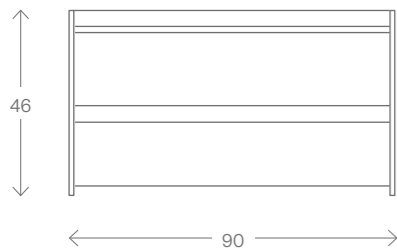

| | |
|-------------------------------|--------------|
| Dimensioni / Dimension | 90x40x46 |
| Confezione / Packaging | 1 Box in Kit |
| Finitura / Texture | |

**Baule contenitore con
chiusura rallentata e
ampio cassetto**
storage trunk, entrance
bench with soft closing
and drawer

LINEA INGRESSI / ENTRANCE





EL 232B

Bianco
White

EL 232BC

Bianco cemento
White beton

EL 232BRR

Bianco rovere rigato
Striped white oak

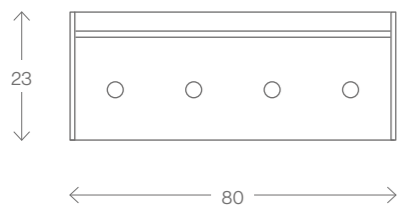

| | |
|-------------------------------|--------------|
| Dimensioni / Dimension | 80x15x23 |
| Confezione / Packaging | 2 Box in Kit |
| Finitura / Texture | |

MADE IN ITALY

LINDESIGNERORI / CABINET





MADE IN ITALY

LINEA INGRESSI / ENTRANCE 95



18+ mm spessore
18+ mm thick



EL 231BROV

Rovere e bianco
Oak and white



Ripiano contenitore
Container shelf



EL 231BC

Cemento e bianco
Beton and white



Tre ganci in materiale
plastico
Three hooks in plastic
material



EL 231B

Bianco
White

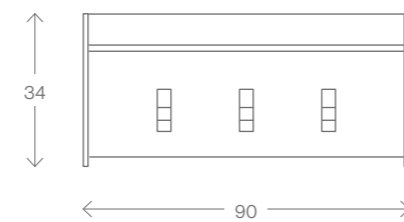

| | |
|-------------------------------|--------------|
| Dimensioni / Dimension | 90x29x34 |
| Confezione / Packaging | 1 Box in Kit |
| Finitura / Texture | |

CONTEMPORANEO, FAMILIARE E ACCOGLIENTE.

CONTEMPORARY, FAMILIAR AND WELCOMING.

MILLEUSI

Mobile multiuso, composto da una pratica anta e sette ampi ripiani interni (posizionabili orizzontali o inclinati). L'ambiente di casa accoglie con naturalezza il mobile, grazie al suo carattere familiare e confortevole.

Multi-purpose cabinet, consisting of a convenient door and seven large internal shelves (that can be placed horizontally or sloped). The ambience naturally welcomes this piece of furniture, thanks to its familiar and comfortable character.

MADE IN ITALY

LINEA INGRESSI / ENTRANCE 97





EL 329B

Bianco
White



EL 329B/CEM

Bianco anta cemento
White beton door



EL 329B/ROV

Bianco anta rovere
White door oak



EL 329BCANCH

Bianco anta canneté chiaro
White door light canneté

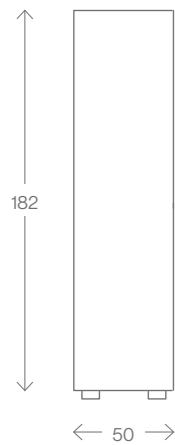

**Sette ripiani orizzontali o inclinati.
Seven horizontal or inclined shelves.**

| | |
|-------------------------------|--------------|
| Dimensioni / Dimension | 50x30x182 |
| Confezione / Packaging | 2 Box in Kit |
| Finitura / Texture | |



MADE IN ITALY



EL 329OLMO/F

Olmo anta fiore
Elm door flowers



EL 329OLMO

Olmo
Elm

| | |
|-------------------------------|--------------|
| Dimensioni / Dimension | 50x30x182 |
| Confezione / Packaging | 2 Box in Kit |
| Finitura / Texture | |



Sette ripiani interni
regolabili da disporre in
orizzontale
Seven adjustable
internal shelves to be
arranged horizontally



Apertura reversibile
Reversible opening



EL 328 B/BETON

Bianco specchio cornice cemento
White mirror beton frame

EL 328 B/BIANCO

Bianco specchio cornice bianco
White mirror white frame

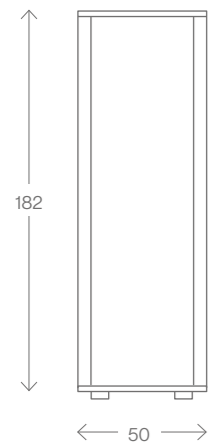

Dimensioni / Dimension 50x32x182

Confezione / Packaging 2 Box in Kit

Finitura / Texture



MADE IN ITALY



SCRIVANIE DESKS

Collezione di scrivanie che unisce funzionalità e stile, ideale per creare un ambiente di lavoro o studio confortevole e stimolante. Queste scrivanie, disponibili in vari stili offrono design unico e materiali di alta qualità, perfetti per soddisfare ogni esigenza lavorativa e decorativa.



MADE IN ITALY

ECO - FRIENDLY

SMART, FUNZIONALE ED EFFICIENTE

SMART, FUNCTIONAL AND EFFICIENT.

DESK

Pratica ed elegante, questa scrivania è un mobile multifunzionale che nasce da una struttura dalle linee semplici e pulite, ma di grande impatto visivo. Il cassetto si rivela di grande utilità, mentre il ripiano a effetto cemento dà il tocco finale.

Practical yet elegant, this desk is a piece of furniture designed with simple and clean lines, yet with a great visual impact. The drawer is handy and convenient, while the concrete effect shelf gives the final touch.



MADE IN ITALY

LINEA SCRIVANIE / DESKS 107



EL 282B

Bianco
White

Dimensioni / Dimension 110x55x75

Confezione / Packaging 1 Box in Kit

Finitura / Texture



MADE IN ITALY



Ripiano contenitore
Container shelf



EL 274BC

Bianco piano cemento
White, beton top

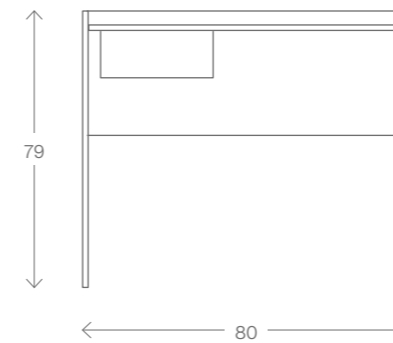

18+ mm spessore
18+ mm thick



EL 274B

Bianco
White

Dimensioni / Dimension 90x60x80

Confezione / Packaging 1 Box in Kit

Finitura / Texture





Cassetto con guide
In metallo
Drawer with guides
Metal



EL 280BROV

Bianco piano rovere
White oak desk



Ampio piano con
vassoio
Large top with tray



EL 280BC

Bianco piano cemento
White, beton desk

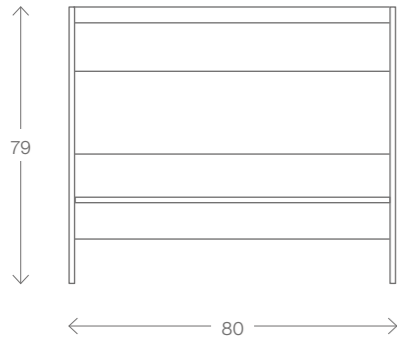

Dimensioni / Dimension

80x40x79

Confezione / Packaging

1 Box in Kit

Finitura / Texture



MADE IN ITALY

LINEA SCRIVANIE / DESKS

3D TEXTURE

18 MM DI
SPESSORE
18 MM THICK



TAVOLI TABLES

Collezione di tavoli allungabili a consolle che unisce stile e funzionalità, ideali per ottimizzare lo spazio in casa. Questi mobili si trasformano da consolle in tavoli da pranzo, offrendo soluzioni salvaspazio in vari stili, dalle linee moderne alle forme classiche.



TRASFORMABILE, INGEGNOSA E DI DESIGN.

TRASFORMABLE, INGENIOUS AND DESIGN.



OPLÀ

Da consolle a tavolo in due semplici mosse: una soluzione elegante adatta ad ogni ambiente. Il pratico sistema a cerniere a ribalta consente di plasmarne la forma senza perderne lo stile. Ideale per una casa moderna che non lascia nulla al caso.

From a simple console to a table in three easy steps: a practical and elegant solution suitable for any ambience, even the smallest one. The convenient flap system changes the table's shape without losing its style. Ideal for a modern home that leaves nothing to chance.

MADE IN ITALY



YouTube

CATAS
RAPPORTO DI PROVA

PIANO
RIBALTABILE
FOLDING FLOOR

GAMBE
ESTENDIBILI
EXTENDABLE
LEGS

LINEA TAVOLI / TABLES

115



Piano spessore 18 mm
18 mm thick top



EL 530BIANCO

Bianco
White

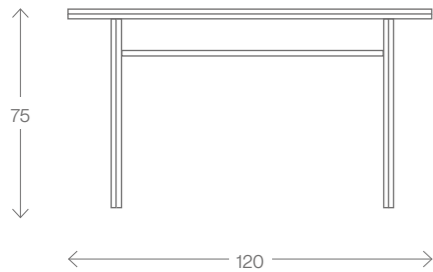

Piano ribaltabile
Folding top



EL 530VI

Vintage
Vintage



EL 530CEM

cemento
Beton

Dimensioni / Dimension 120x35/70x75

Confezione / Packaging 1 Box in Kit

Finitura / Texture



PIEGHEVOLE, ADATTABILE E COMODO.

FOLDABLE, ADAPTABLE AND COMFORTABLE.



FLEX

Versatile, pratico e adatto ad ogni situazione, questo tavolo con gambe pieghevoli rappresenta una efficace soluzione per gli spazi ridotti o le gite fuoriporta. Un design semplice eppure elegante regala un complemento d'arredo che non ha paura degli imprevisti.

Versatile, practical and suitable for any situation, this leg folding table is an effective solution for reduced space or road trips. A simple yet elegant design gives a piece of furniture that is always useful.



MADE IN ITALY

LINEA TAVOLI / TABLES

119



MADE IN ITALY



Piano spessore 22 mm
22 mm thick top



Gambe pieghevoli
in metallo
Folding metal legs



EL 25ROV

Rovere
Oak



EL 25B

Bianco
White

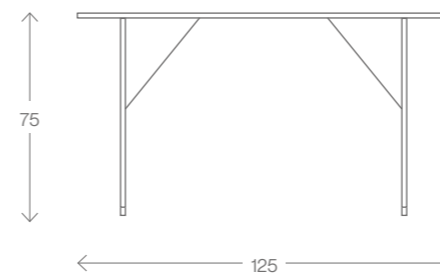

Dimensioni / Dimension 125x75x80

Confezione / Packaging 1 Box in Kit

Finitura / Texture



STILOSO, ALLUNGABILE E FACILE DA USARE.

STILISH, EXTENDABLE AND EASY TO USE.



EXTEND

Da consolle a tavolo in tre semplici mosse: una soluzione pratica ed elegante adatta ad ogni ambiente, anche quello più piccolo. Tre allunghe, posizionate all'interno del tavolo con guida in metallo, consentono di plasmarne la forma senza perderne lo stile. Consegnato già montato.

From a simple console to a table in three easy steps: a practical and elegant solution suitable for any ambiance, even the smallest one. Three extensions, positioned inside the table with a metal rail, change the table's shape without losing its style. Delivered already assembled.

MADE IN ITALY

LINEA TAVOLI / TABLES 123



YouTube

CATAST ESTED
CATAS
RAFFORTO DI PROVA



EL 540NOCE

Noce
Walnut

Dimensioni / Dimension 80x44/186x76

Confezione / Packaging 2 Box in Kit

Finitura / Texture





Contenitore plastico per prolunghe
Plastic container for extension cords



Tre possibilità di apertura fino a 186 cm
Three opening possibilities up to 186 cm



EL 540B

Bianco
White



EL 540BETON

Cemento
Beton



EL 540BEIGE

Beige
Beige

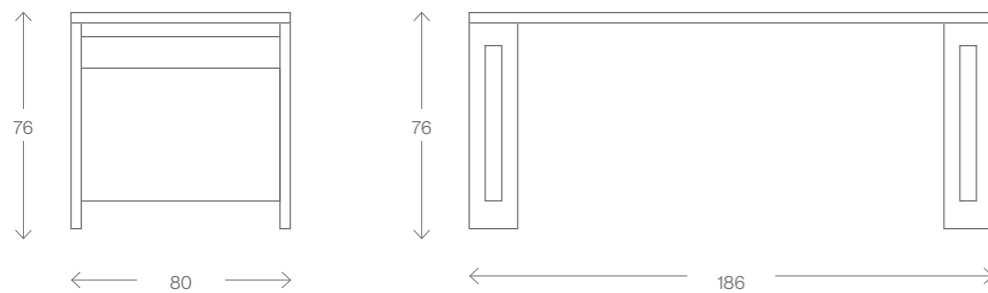

| | |
|-------------------------------|--------------|
| Dimensioni / Dimension | 80x44/186x76 |
| Confezione / Packaging | 2 Box in Kit |
| Finitura / Texture | |



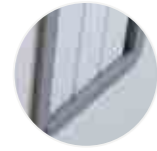

Contenitore plastico per prolunghe
Plastic container for extension cords



Tre possibilità di apertura fino a 186 cm
Three opening possibilities up to 186 cm

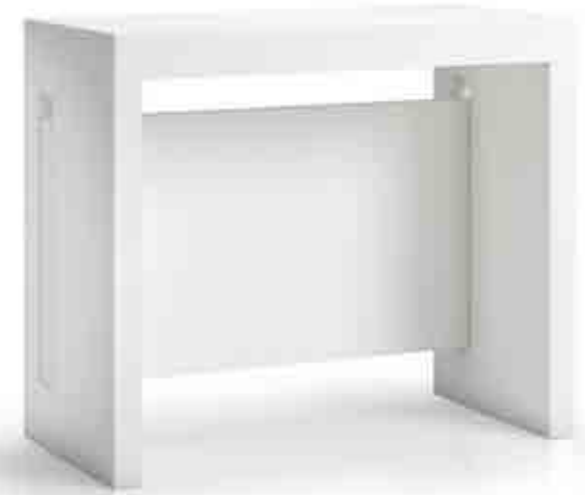

EL 549B

Bianco
White



EL 549BETON

Cemento
Beton

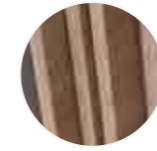

Console estendibile
Extensible console



EL 549ROVERE

Rovere
Oak

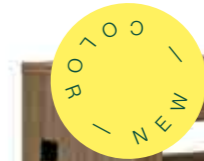

EL 549NOCE

Noce
Walnut

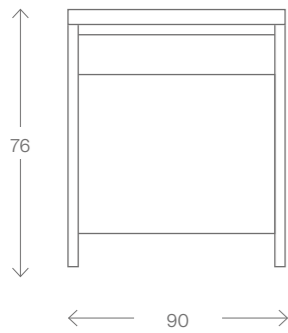

Dimensioni / Dimension

90x44/186x76

Confezione / Packaging

2 Box in Kit

Finitura / Texture





EL 549BEIGE

Beige
Beige

Dimensioni / Dimension 90x44/186x76

Confezione / Packaging 2 Box in Kit

Finitura / Texture



CASSETTIERE DRAWERS

Collezione di cassettiere che unisce stile e funzionalità, ideali per organizzare lo spazio in casa. Disponibili in vari materiali e design, offrono un utilizzo pratico e silenzioso, perfette per ambienti moderni o classici.



CONTENITIVO, MODERNO E MULTIAMBIENTE.

CONTAINER, MODERN AND ALL-AROUND
(MULTI-ENVIRONMENT).

CONTEMPORARY

Un mobile multifunzionale che nasce da una struttura dalle linee semplici e pulite, ma di grande impatto visivo. L'anta e i quattro cassetti possono contenere diversi oggetti, mentre il ripiano a effetto cemento conclude l'opera. Nella versione cassetiera all'apparenza semplice, ma completa di quattro cassetti e ripiano a effetto cemento. Non solo una colorazione particolare, ma anche una forma tutta nuove che ricorda un pratico vassoio portaoggetti. Disponibile in varie finiture.

A multifunctional cabinet designed with simple and clean lines, yet with a great visual impact. The door and the four drawers can contain several objects, while the concrete effect shelf concludes the work. Available in the version with a simple chest of drawers, complete with four drawers and a concrete effect shelf. Not only a special colour but also a whole new shape: the shelf has a side border, becoming a practical storage tray. Available in different finishing."

MADE IN ITALY

LINEA CASSETTIERE / DRAWERS

137





Vassoio superiore
Top tray

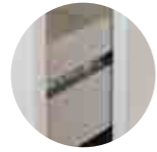

Quattro cassetti con
guide in metallo
Four drawers with
metal slides



EL 240BC

Bianco piano
cemento
White, beton top



EL 240CEM

Cemento frontali bianco
Beton and white



EL 240BROV

Rovere frontali bianco
Oak and white

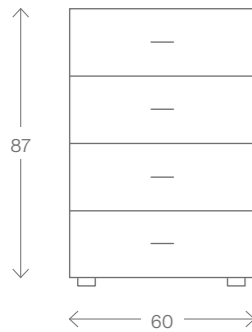

| | |
|-------------------------------|---|
| Dimensioni / Dimension | 60x41x87 |
| Confezione / Packaging | 1 Box in Kit |
| Finitura / Texture |  |



Vassoio superiore
Top tray

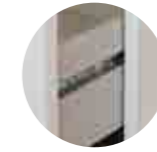

Quattro cassetti con
guide in metallo
Four drawers with
metal runners



Anta con ripiano
interno
Door with internal
shelf



EL 245BC

Bianco piano
cemento
White, beton top



EL 245CEM

Cemento frontali bianco
Beton and white



EL 245BROV

Rovere con frontali bianco
Oak and white

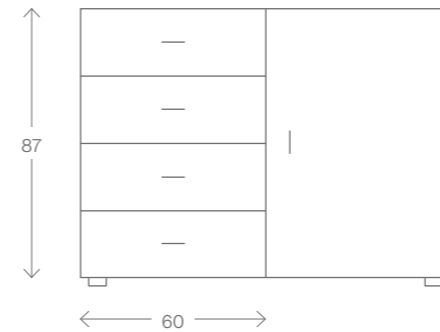

| | |
|-------------------------------|---|
| Dimensioni / Dimension | 90x41x87 |
| Confezione / Packaging | 2 Box in Kit |
| Finitura / Texture |  |



Materiali antiraffio
Scratch resistant materials



EL 242B

Bianco
White



Nuova texture
New texture



EL 242BRR

Bianco cassetto rovere rigato
White stripped oak drawer

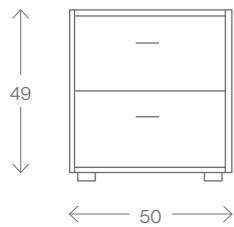

**Il perfetto equilibrio tra
stile e praticità.
The perfect balance
between style and
practicality.**

Dimensioni / Dimension 50x39x49h

Confezione / Packaging 1 Box in Kit

Finitura / Texture

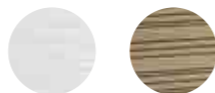

MADE IN ITALY

LINEA CASSETTIERE / DRAWERS





MADE IN ITALY



Quattro cassetti con
guide in metallo
Four drawers with
metal slides



Nuova texture
New texture



EL 244B

Bianco
White



EL 244BRR

Bianco cassetto rovere rigato
White stripped oak drawer

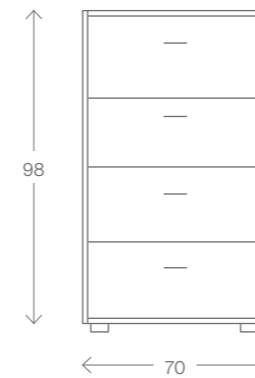

**Ampia capacità con
quattro cassetti Spaziosi.
storage trunk, entrance
bench with soft closing
and drawer.**

Dimensioni / Dimension 70x39x98

Confezione / Packaging 1 Box in Kit

Finitura / Texture



SCARPIERE SHOECABINET

Collezione di scarpiera singola o doppia profondità, disponibili con 3, 4 o 5 ante a ribalta, e versioni armadio con due ante. Queste soluzioni offrono grande capacità di stoccaggio e versatilità, adattandosi perfettamente a vari stili di arredamento e ottimizzando lo spazio in ingresso o corridoio.



MADE IN ITALY

ECO - FRIENDLY

POLIEDRICO, INNOVATIVO E PERSONALIZZABILE.

MULTIFACETED, INNOVATIVE AND CUSTOMIZABLE.

EXTRASPAZIO

Un armadio multifunzionale che nasce da una struttura dalle linee semplici e pulite, ma di grande impatto visivo. Il mobile può essere interpretato da chi lo utilizza, poiché perfetto per ogni stanza della casa. Le due ante celano un cassetto interno e ben sei ripiani.

A multifunctional cabinet designed with simple and clean lines, yet with a great visual impact. This piece of furniture can be interpreted by those who use it, as it is perfect for every room in your home. The two doors conveniently mask an internal drawer and six shelves.





Sei ripiani interni
Six internal shelves

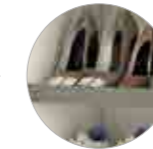

Fermascarpe
Shoe clips



Cassetto interno
Inner drawer



EL 109B/OLMO

Bianco ante olmo
White door elm

EL 109B

Bianco
White



EL 109/1CEM

bianco anta cemento con specchio
White, beton with mirror

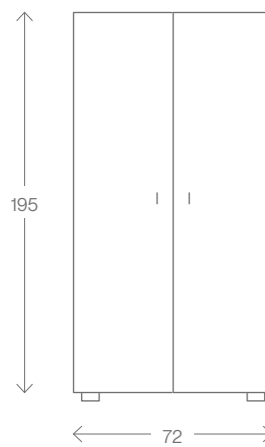

EL 109/1B

Bianco ante bianco con specchio
White door white with mirror

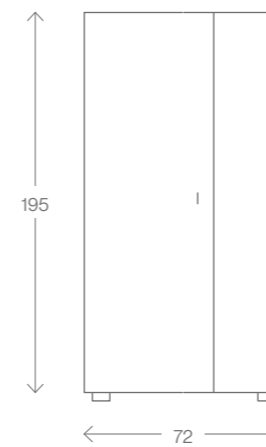

| | |
|-------------------------------|---|
| Dimensioni / Dimension | 72x37x195 |
| Confezione / Packaging | 2 Box in Kit |
| Finitura / Texture |   |



| | |
|-------------------------------|---|
| Dimensioni / Dimension | 72x37x195 |
| Confezione / Packaging | 2 Box in Kit |
| Finitura / Texture |   |

DOPPIA PROFONDITÀ, DOPPIO CONTENITORE E INFINITE PERSONALIZZAZIONI.

DOUBLE DEPTH, DOUBLE CABINET AND INFINITE
MULTI-CUSTOMIZATIONS.

SETTEMILA SCARPIERE DOPPIE

Una scarpiera che si fonde con lo stile della tua casa: scopri la comodità di tre, quattro, cinque ante, dotate di sicuro sistema a ribalta, dalla doppia profondità. Un mobile utile ed elegante per disporre fino a diciotto paia scarpe in modo ordinato e in poco spazio.

A shoe cabinet that blends in with the style of your home: discover the convenience of three, four, five doors, with a secure double-decker system. A handy and stylish piece of furniture designed to give your shoes, up to eighteen pairs, the right order.





Maniglia ergonomica
ergonomic handle

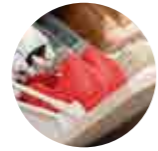

Doppia profondità 6
paia per anta
Double depth 6 pairs
per door



Piedini in materiale
plastico
Feet in plastic material



Tre ante a ribalta
Three flap doors



EL 7003 B/BIANCO

Bianco
White



EL 7003 T/LARICE

Tessuto ante larice
Textil doors larix



EL 7003BC

Bianco ante cemento
White doors beton



EL 7003BETON

Cemento
Beton



EL 7003CEMLEI

Cemento anta tessuto
leizu
Beton flower door



EL 7003OLMO/F

Olmo ante fiore
Elm doors flowers

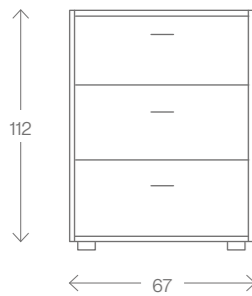

**Contiene 18 paia di scarpe.
Contains 18 pairs of shoes.**

Dimensioni / Dimension 67x28x112

Confezione / Packaging 1 Box in Kit

Finitura / Texture



**DOPPIA
PROFONDITÀ**
DOUBLE
DEPTH



MADE IN ITALY



Tre ante a ribalta
Three flap doors



EL 7003OLMO

Olmo
Elm

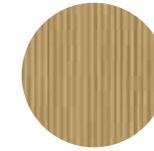

EL 7003BCANCH

Cannetè chiaro
Light cannètè

Dimensioni / Dimension 67x28x112

Confezione / Packaging 1 Box in Kit

Finitura / Texture





Maniglia ergonomica
ergonomic handle

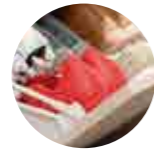

Doppio contenitore
plastico per scarpe
Double plastic
container for shoes



Piedini in materiale
plastico
Feet in plastic
material

MADE IN ITALY



Quattro ante a ribalta
Four flap doors



EL 7004 B/BIANCO

Bianco
White



EL 7004 TL

Tessuto ante larice
Textil doors larix



EL 7004BC

Bianco ante cemento
White doors beton



EL 7004BETON

Cemento
Beton



EL 7004BCANCH

Olmo
Elm



EL 7004OLMO/F

Olmo ante fiore
Elm doors flowers

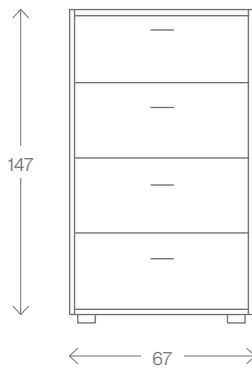

**Contiene 24 paia di scarpe.
Contains 24 pairs of shoes.**

| | |
|-------------------------------|--------------|
| Dimensioni / Dimension | 67x28x147 |
| Confezione / Packaging | 1 Box in Kit |
| Finitura / Texture | |



BESTSELLERS



EL 7005B/BIANCO

Bianco
White



EL 7005BC

Bianco ante cemento
White doors beton



EL 7005BETON

Cemento
Beton

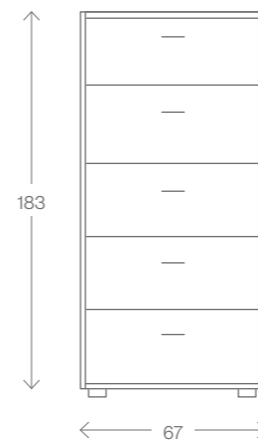

Contiene 30 paia di scarpe.
Contains 30 pairs of shoes.

| | |
|-------------------------------|--------------|
| Dimensioni / Dimension | 67x28x183 |
| Confezione / Packaging | 2 Box in Kit |
| Finitura / Texture | |

SLIM, COMPATTA E ADATTABILE.

SLIM, COMPACT AND ADAPTABLE.

SIMPLE SCARPIERE COMPATTE

Una scarpiera che si fonde con lo stile della tua casa: scopri la comodità di tre, quattro ante, dotate di sicuro sistema a ribalta, dalla singola profondità. Un mobile utile ed elegante per disporre fino a nove paia scarpe in modo ordinato e in poco spazio.

A shoe cabinet that blends in with the style of your home: discover the convenience of three, four doors, with a secure single-decker system. A handy and stylish piece of furniture designed to give your shoes, up to nine pairs, the right order.





Salvaspazio 18cm di profondità
Space saving 18cm deep



Maniglia Ergonomica
Ergonomic handle



EL 6005 B

Bianco
White

EL 6005 TL

Tessuto ante larice
Textile doors larix



Quattro ante a ribalta
Four flap doors



Piedini in materiale plastico
Feet in plastic material

EL 6005 BC

Bianco ante cemento
White beton



EL 6005 LEI

Bianco ante leizu
White leizu

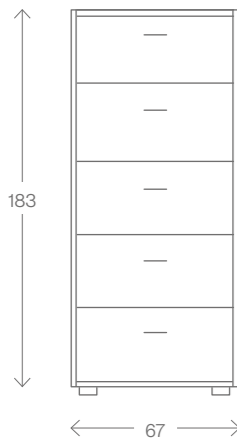

**Contiene 15 paia di scarpe.
Contains 15 pairs of shoes.**

Dimensioni / Dimension 67x18x183

Confezione / Packaging 1 Box in Kit

Finitura / Texture





MADE IN ITALY

LINEA SCARPIERE / SHOECABINET 165



Tre ante a ribalta
Three flap doors



Salvaspazio 17cm
di profondità
Space saving
17cm deep



Contiene 9 paia
Contains 9 pairs



EL 6003B

Bianco
White



EL 6003BC

Bianco ante cemento
White doors beton



EL 6003TL

Tessuto ante larice
Textile doors larix

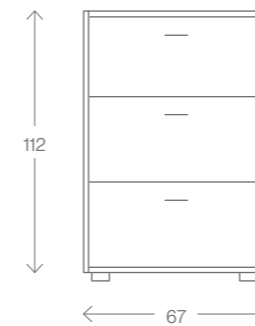

**Contiene 9 paia di scarpe.
Contains 9 pairs of shoes.**

Dimensioni / Dimension 67x18x112

Confezione / Packaging 1 Box in Kit

Finitura / Texture





Anta a specchio con apertura reversibile
Mirror door with reversible opening



Maniglia a scomparsa
Retractable handle

EL 301 B

Bianco specchio
White mirror

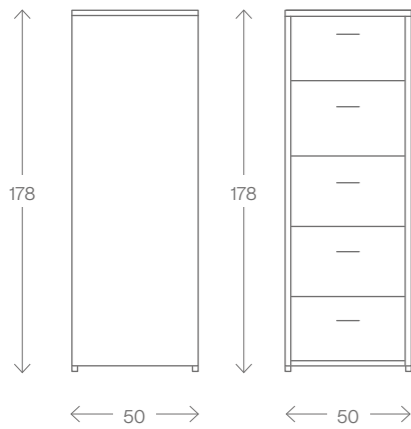

Contiene 10 paia di scarpe.
Contains 10 pairs of shoes.



Contiene 10 paia
Contains 10 pairs

EL 4000 B

Bianco
White

| | |
|-------------------------------|--------------|
| Dimensioni / Dimension | 50x18x178 |
| Confezione / Packaging | 1 Box in Kit |
| Finitura / Texture | |

MADE IN ITALY





design firm **mptdesign.**

MADE IN ITALY



Verano Brianza (MB)
Via Furlanelli, 31 - 20843
T. +39_0362_903377

info@terraneo.com
www.terraneo.com

